













Dati Tecnici - Specifications

	 cond	 comp. W	 ABS. W	 Fuse	 Kwh/100Kg	 I / h	 kg		 Lbs		 Ton CO2 equiv.
CS25 A		667	460	10	42.7	2,08	34	75	42	93	0,329
CS25 W		667	410	10	37.5	32,3	34	75	42	93	0,286



Produzione Ghiaccio - Ice Production

Raffreddamento ad aria - Air Cooled Unit

Temp. Aria Air Temp.	Temp. Acqua / Water Temp.				
		32°	21°	15°	10°
°C		32°	21°	15°	10°
°F		90°	70°	60°	50°
10°	17	21	22	24	
50°	37	46	49	53	
21°	16	20	21	23	
70°	35	44	46	51	
32°	14	18	19	21	
90°	31	40	42	46	
38°	12	15	16	17	
100°	26	33	35	37	

Raffreddamento ad acqua - Water Cooled Unit

Temp. Aria Air Temp.	Temp. Acqua / Water Temp.				
		32°	21°	15°	10°
°C		32°	21°	15°	10°
°F		90°	70°	60°	50°
10°	20	20.5	21.5	22.5	
50°	44	45	47	50	
21°	19.5	20	21	22	
70°	43	44	46	49	
32°	16.5	17.5	18.5	19.5	
90°	36	39	41	43	
38°	15	16	17	18	
100°	33	35	37	40	



PANNELLO DI CONTROLLO - CONTROL PANEL



Interruttore On/Off
Switch On/Off

Size ice regulation screw
Vite regolazione
dimensione ghiaccio

CAPACITA' DEPOSITO - BIN CAPACITY

7 Kg - 15.4 lbs 350 pcs

DIMENSIONI - DIMENSIONS

LxPxH (mm / inch)

 400 x 480 x 600
16" 12/16 x 19" 14/16 x 24" 10/16

 460 x 600 x 850
18" 2/16 x 23" 10/16 x 33" 7/16

TIPO GHIACCIO - ICE TYPE

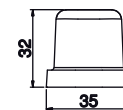

20g
WEIGHT ICE
PESO GHIACCIO



18
PCS / CYCLE
PZ/CICLO

CONDIZIONI USO-OPERATING REQUIREMENTS





Calore espulso / Rejected Heat 1056 W

Volume aria / Air Volume 185 m³/h



220-240/50/1

R134a GWP = 1430

MIN		MAX
10°C (50°F)		40°C (104°F)
5°C (41°F)		35°C (95°F)
- 10 %		+ 10 %
1 Bar (14 psi)		5 Bar (70 psi)

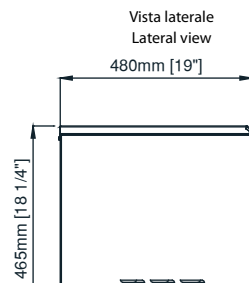
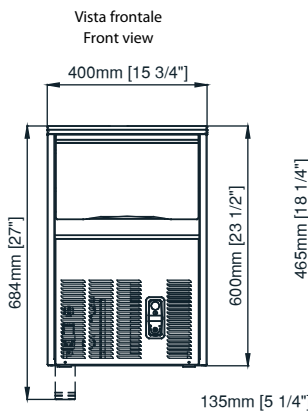

Interruttore ON-OFF
Switch ON-OFF



Size ice regulation screw
Vite regolazione
dimensione ghiaccio

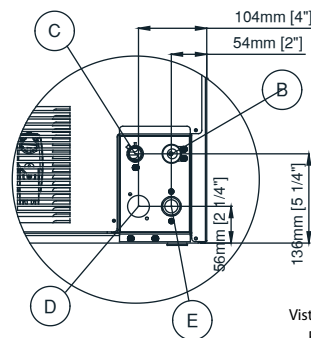
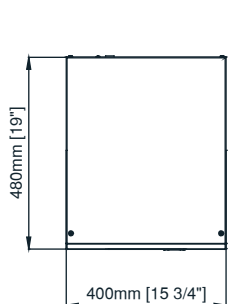

Vista posteriore
Rear view

- A** Electrical cable supply / Ingresso alimentazione elettrica
- B** Water outlet connection / Attacco scarico acqua diam. 20 mm

- C** Water inlet connection / Attacco entrata acqua - 3/4" gas
- D** Water outlet connection water condensation / Uscita acqua condensatore ad acqua diam. 20 mm



Kit 4 Feet Optional
Kit 4 piedini Optional
Ø50mm H100-120 mm